

Question 1(a) [3 marks]

Explain different types of maintenance in brief.

Answer:

Type of Maintenance	Description
Preventive Maintenance	Scheduled regular inspection and servicing to prevent breakdowns
Corrective Maintenance	Repairs performed after equipment failure to restore functionality
Predictive Maintenance	Uses condition monitoring to predict when maintenance will be needed

Mnemonic: "PCPro" - Preventive prevents, Corrective cures, Predictive predicts

Question 1(b) [4 marks]

Explain maintenance procedure of Washing Machine.

Answer:

Maintenance Procedure for Washing Machine:



- **Filter Cleaning:** Remove and clean lint filter monthly
- **Hose Inspection:** Check for cracks and leaks every 3 months
- **Load Distribution:** Ensure proper balancing to prevent vibration
- **Drum Cleaning:** Run empty hot water cycle with vinegar quarterly

Mnemonic: "FHLD" - Filters, Hoses, Loads, Drum need regular attention

Question 1(c) [7 marks]

Explain maintenance and troubleshooting procedure of Microwave Oven.

Answer:

Maintenance and Troubleshooting for Microwave Oven:

Maintenance Task	Procedure	Frequency
External Cleaning	Wipe with mild detergent	Weekly
Internal Cleaning	Clean food particles and grease	After each spill
Door Seal Check	Inspect for damage or leakage	Monthly
Ventilation Check	Ensure vents are unobstructed	Monthly

Troubleshooting Procedure:

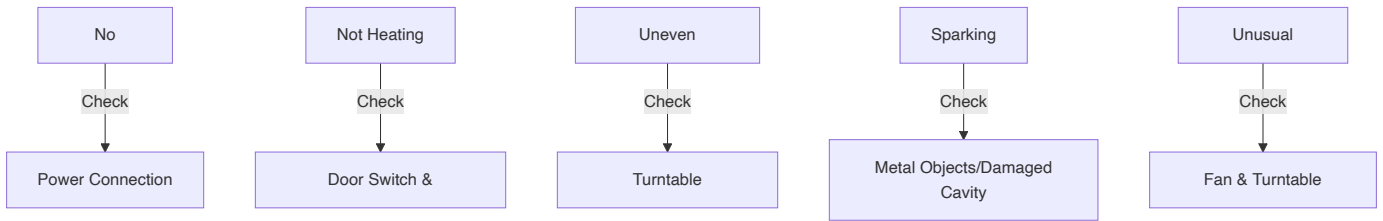

- **Power Issues:** Check fuse, circuit breaker, and cord
- **Heating Problems:** Test door switch, high voltage capacitor, magnetron
- **Safety First:** Never operate with damaged door or seals

Mnemonic: "POWER" - Power, Oven interior, Wiring, Electronics, Radiation seals

Question 1(c OR) [7 marks]

Explain maintenance and troubleshooting procedure of projector.

Answer:

Maintenance and Troubleshooting for Projector:

Maintenance Task	Procedure	Frequency
Lens Cleaning	Use lens cloth and solution	Monthly
Filter Cleaning	Remove and clean dust	Every 100 hours
Lamp Inspection	Check for discoloration/dimming	Every 300 hours
Ventilation	Ensure proper airflow	Before each use

Troubleshooting Procedure:

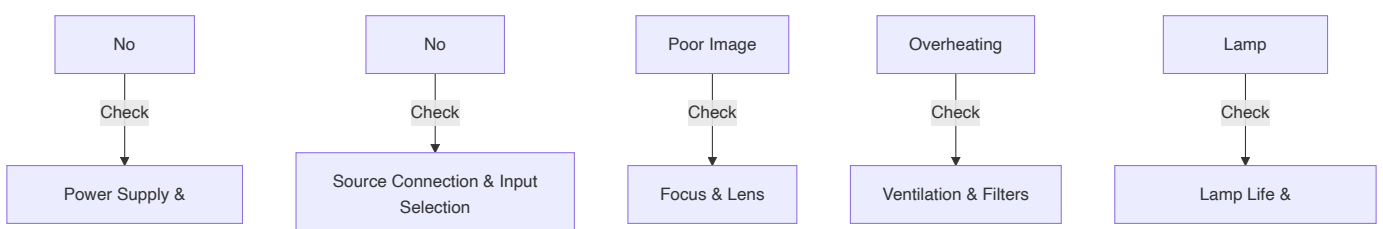

- **Image Issues:** Adjust focus, resolution, keystone correction
- **Lamp Problems:** Check lamp hours, replace if exceeding limit
- **Connectivity:** Verify input source and cable connections
- **Thermal Issues:** Clean filters and ensure proper ventilation

Mnemonic: "FLAMVE" - Filters, Lamp, Airflow, Mounting, Voltage, Environment

Question 2(a) [3 marks]

Explain the terms in brief: (1) Hue (2) Brightness

Answer:

Term	Description
Hue	The pure color attribute that distinguishes colors (red, green, blue, etc.) based on light wavelength
Brightness	The amount of light emitted or reflected from a color, determining how light or dark it appears

Diagram:

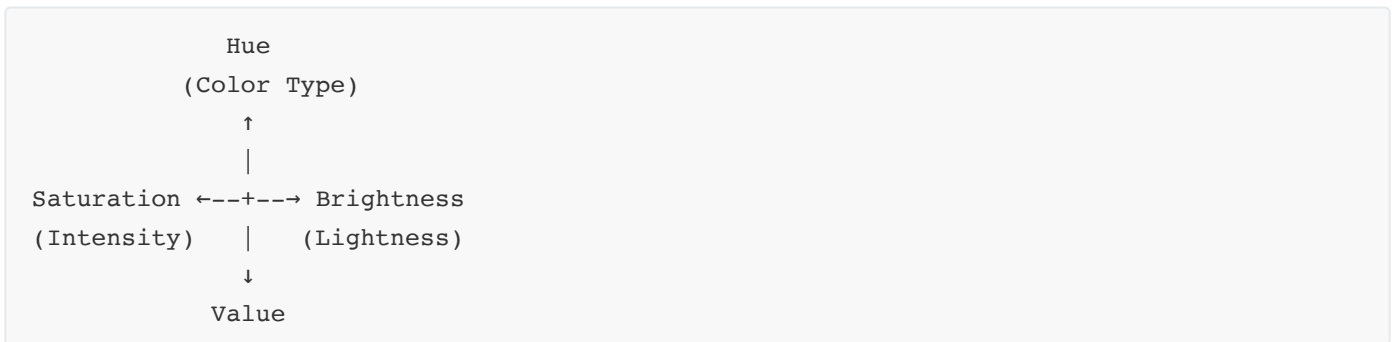

Mnemonic: "HB-WC" - Hue determines What Color, Brightness determines White-to-black level

Question 2(b) [4 marks]

Write a short note on LCD TV.

Answer:

LCD TV Technology:

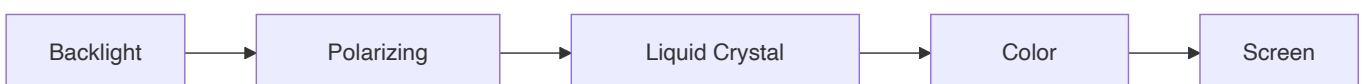

- **Working Principle:** Uses liquid crystals that twist/untwist to allow/block light
- **Key Components:** Backlight, polarizing filters, liquid crystal matrix, color filters
- **Advantages:** Thin profile, energy efficient, no radiation, sharp image

- **Limitations:** Limited viewing angle, slower response time than newer technologies

Mnemonic: "BPLCS" - Backlight Passes Light through Crystals to Screen

Question 2(c) [7 marks]

Draw and explain block diagram of DTH receiver.

Answer:

DTH Receiver Block Diagram:

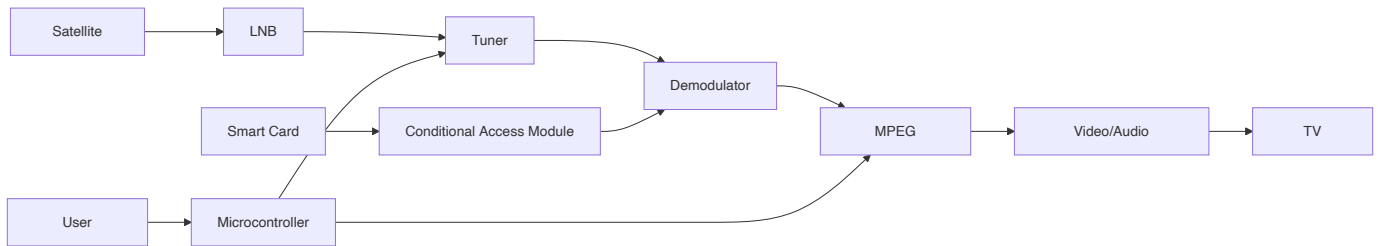

- **Satellite Dish:** Captures signals from satellite
- **LNB (Low Noise Block):** Converts high frequency signals to lower frequency
- **Tuner:** Selects specific channel frequency
- **Demodulator:** Extracts digital information from carrier signal
- **MPEG Decoder:** Decompresses video/audio data
- **Conditional Access Module:** Controls subscription access
- **Microcontroller:** Controls overall operation and user inputs

Mnemonic: "SLTDMP" - Satellite, LNB, Tuner, Demodulator, MPEG, Processor

Question 2(a OR) [3 marks]

Explain the terms in brief: (1) Luminance (2) chrominance

Answer:

Term	Description
Luminance	The brightness or intensity component of a video signal (Y) that carries black and white information
Chrominance	The color component of a video signal (Cb, Cr) that carries hue and saturation information

Diagram:

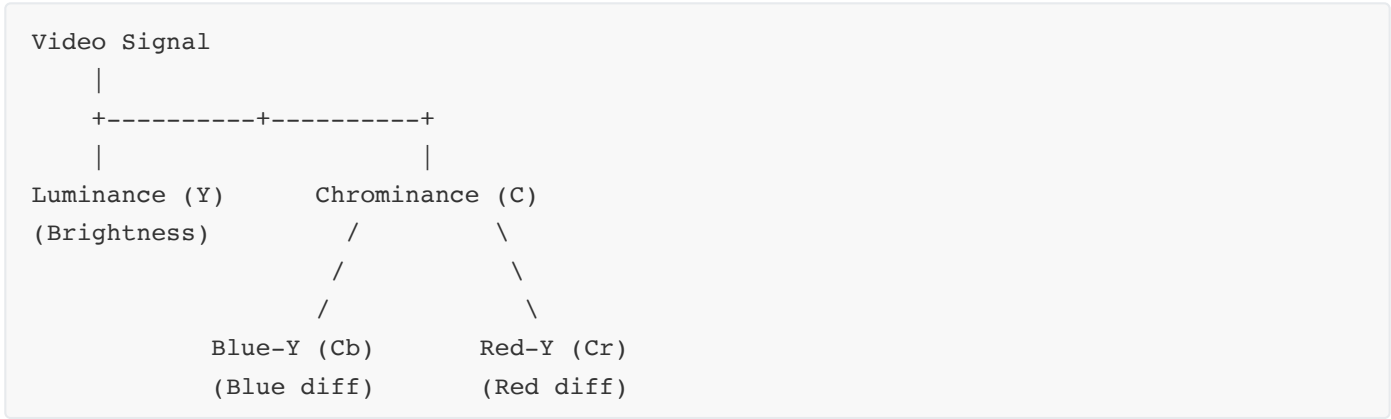

Mnemonic: "LC-BH" - Luminance controls Brightness, Chrominance controls Hue

Question 2(b OR) [4 marks]

Explain Grassman's law.

Answer:

Grassman's Laws of Color Mixing:

Law	Description
Symmetry	If color A matches color B, then B matches A
Proportionality	If A matches B, then nA matches nB (for any intensity n)
Additivity	If A matches B and C matches D, then A+C matches B+D

- **Application:** Forms the basis of RGB color model in displays
- **Significance:** Allows creating any color by mixing three primary colors
- **Limitation:** Applies only to light (additive mixing), not pigments

Mnemonic: "SPA Color" - Symmetry, Proportionality, Additivity laws for Color matching

Question 2(c OR) [7 marks]

Draw and explain block diagram of colour TV receiver.

Answer:

Colour TV Receiver Block Diagram:

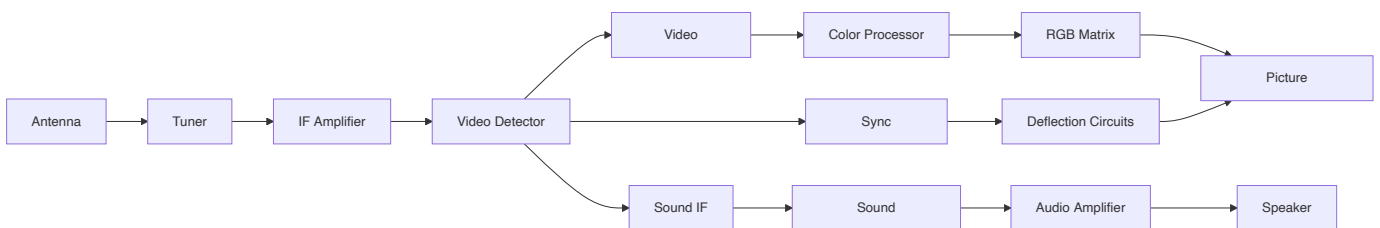

- **Tuner:** Selects desired channel frequency

- **IF Amplifier:** Amplifies intermediate frequency signals
- **Video Detector:** Extracts video and audio information
- **Color Processor:** Separates luminance and chrominance
- **RGB Matrix:** Converts color signals to red, green, blue
- **Sync Separator:** Extracts horizontal and vertical sync
- **Deflection Circuits:** Control electron beam scanning

Mnemonic: "TIVCRDS" - Tuner, IF, Video, Color, RGB, Deflection, Speaker

Question 3(a) [3 marks]

State main components of solar power system and specifications of solar power system.

Answer:

Main Components of Solar Power System:

Component	Function
Solar Panels	Convert sunlight to electricity
Charge Controller	Regulates battery charging
Battery Bank	Stores electrical energy
Inverter	Converts DC to AC electricity
Mounting Structure	Supports and positions panels

Specifications:

- **Panel Rating:** 100-400W per panel
- **Battery Capacity:** 100-200Ah
- **Inverter Rating:** 500-5000W
- **System Voltage:** 12/24/48V

Mnemonic: "SCBIM" - Solar panels, Controller, Battery, Inverter, Mounting

Question 3(b) [4 marks]

List types, applications and technical specifications of microwave oven.

Answer:

Types of Microwave Ovens:

Type	Features
Solo	Basic heating and defrosting only
Grill	Additional grilling element
Convection	Has heating element and fan for baking
Combination	Integrates microwave, grill and convection

Applications:

- Food reheating
- Defrosting
- Cooking
- Baking (convection models)

Technical Specifications:

- **Power:** 700-1200 Watts
- **Capacity:** 20-40 Liters
- **Frequency:** 2.45 GHz
- **Voltage:** 220-240V AC

Mnemonic: "SGCC" - Solo, Grill, Convection, Combo ovens for various cooking needs

Question 3(c) [7 marks]

Explain working of Air conditioner and Refrigerator

Answer:

Working Principle of Air Conditioner and Refrigerator:

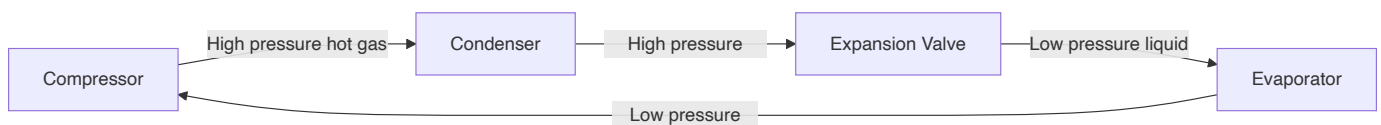

Common Components:

- **Compressor:** Pressurizes refrigerant gas
- **Condenser:** Releases heat, converts gas to liquid
- **Expansion Valve:** Reduces pressure of liquid refrigerant
- **Evaporator:** Absorbs heat, converts liquid to gas

Differences:

Aspect	Air Conditioner	Refrigerator
Purpose	Cools entire room	Maintains cold in insulated cabinet
Temperature	18-26°C typically	2-8°C (fridge), -18°C (freezer)
Control	Thermostat with remote	Manual or digital thermostat

Mnemonic: "CEVA" - Compression, Expansion, Vaporization, Absorption cycle

Question 3(a OR) [3 marks]

List technical specifications of Air conditioner and Refrigerator

Answer:

Technical Specifications:

Specification	Air Conditioner	Refrigerator
Cooling Capacity	1-2 ton (12,000-24,000 BTU)	100-500 liters capacity
Power Consumption	1000-2500 watts	100-400 watts
Energy Efficiency	ISEER/Star Rating 3-5	BEE Star Rating 3-5
Refrigerant Type	R32, R410A	R600a, R134a
Voltage/Frequency	220-240V/50Hz	220-240V/50Hz

Mnemonic: "CPERS" - Capacity, Power, Efficiency, Refrigerant, Supply specifications

Question 3(b OR) [4 marks]

Explain electronic controller for washing machine.

Answer:

Electronic Controller for Washing Machine:

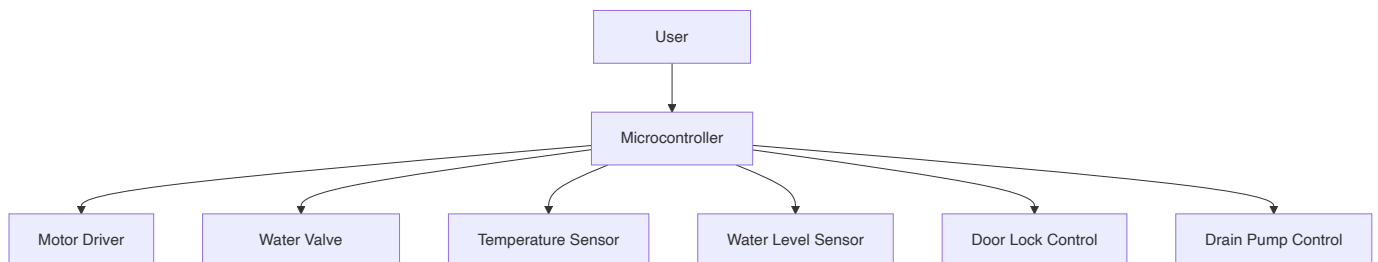

- **Microcontroller:** Central processing unit that controls all operations
- **Sensors:** Water level, temperature, load balance, door position
- **Actuators:** Motor driver, water valves, heater, drain pump

- **User Interface:** Program selection, temperature, spin speed settings

Mnemonic: "MIST-WAD" - Microcontroller Integrates Sensors and Timers for Water, Agitation and Drainage

Question 3(c OR) [7 marks]

Draw and explain block diagram of Microwave oven. List wiring and safety instructions for microwave oven

Answer:

Microwave Oven Block Diagram:

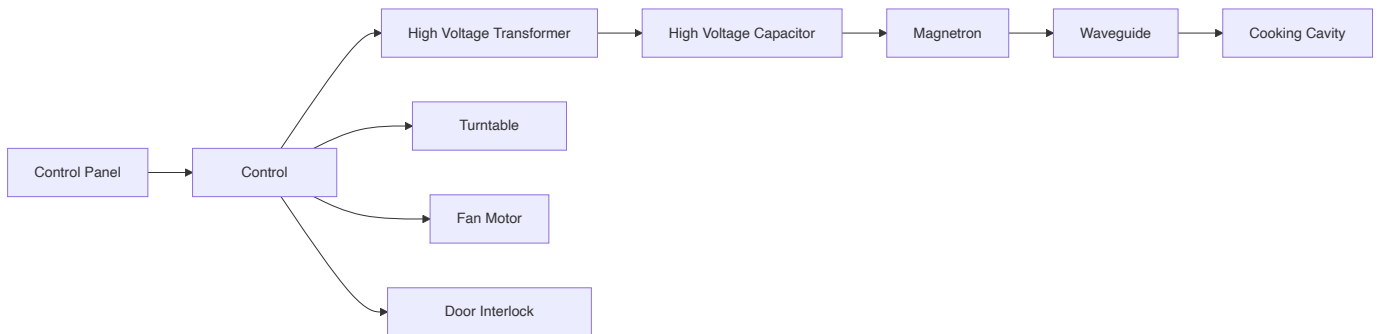

- **Control Circuit:** Processes user inputs and controls timing
- **High Voltage Transformer:** Steps up voltage to 2000-4000V
- **Magnetron:** Generates microwave radiation at 2.45 GHz
- **Waveguide:** Directs microwaves into cooking cavity
- **Turntable:** Ensures even cooking through rotation

Safety Instructions:

- Never operate with door open or damaged
- Ensure proper grounding
- Don't override safety interlocks
- Use microwave-safe containers only

Wiring Instructions:

- Use appropriate gauge power cable (typically 14-16 AWG)
- Connect to dedicated 15-20A circuit
- Ensure proper ground connection
- Keep wiring away from heat sources

Mnemonic: "MAGIC" - Magnetron And Guided waves Into Cavity

Question 4(a) [3 marks]

Draw block diagram of Photocopier.

Answer:

Photocopier Block Diagram:

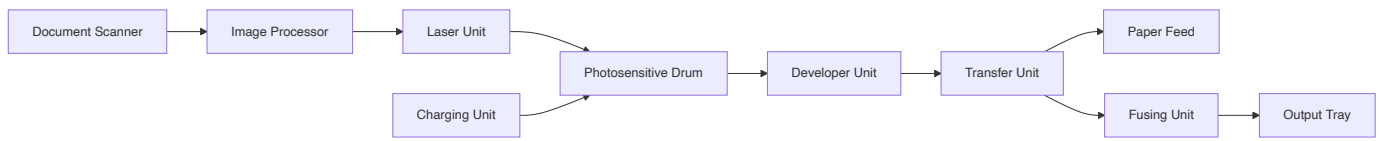

- **Scanner:** Captures original document image
- **Drum:** Holds electrostatic image
- **Developer:** Applies toner to charged areas
- **Transfer:** Transfers toner to paper
- **Fuser:** Melts toner permanently onto paper

Mnemonic: "SDTFO" - Scan, Develop, Transfer, Fuse, Output

Question 4(b) [4 marks]

List specifications of MF printer and CCTV.

Answer:

Specifications:

MF Printer Specifications	CCTV Specifications
Print Resolution: 600-1200 dpi	Camera Resolution: 2-8 MP
Print Speed: 15-40 ppm	Frame Rate: 15-30 fps
Scan Resolution: 300-600 dpi	Storage: 1-8 TB HDD/NVR
Paper Capacity: 150-500 sheets	Night Vision: 10-30m range
Connectivity: USB, Ethernet, Wi-Fi	Connectivity: Coaxial/IP/Wireless
Functions: Print, Scan, Copy, Fax	Video Format: H.264/H.265

Mnemonic: "RSCPF" - Resolution, Speed, Capacity, Protocol, Function specifications

Question 4(c) [7 marks]

Explain working of laser printer with block diagram.

Answer:

Laser Printer Working:

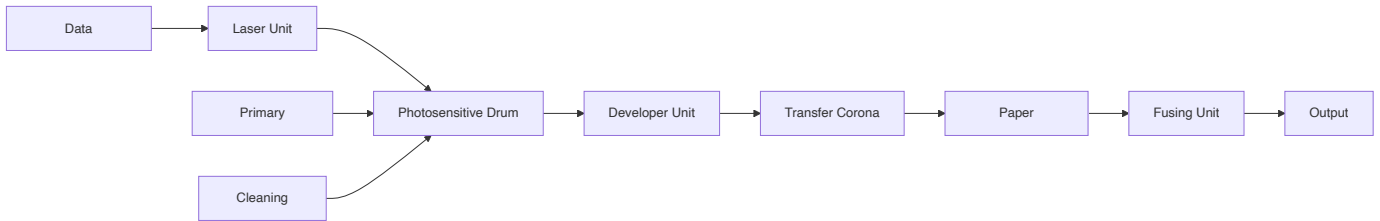

Working Process:

1. **Charging:** Corona wire gives drum uniform negative charge
 2. **Writing:** Laser neutralizes charges on drum to form image
 3. **Developing:** Toner adheres to discharged areas of drum
 4. **Transfer:** Paper receives positive charge, attracts toner
 5. **Fusing:** Heat and pressure melt toner onto paper
 6. **Cleaning:** Residual toner is removed from drum
- **Resolution:** Determined by laser precision (600-1200 dpi)
 - **Speed:** Based on drum rotation and paper transport (15-40 ppm)

Mnemonic: "CWTFCC" - Charge, Write, Transfer, Fuse, Clean cycle

Question 4(a OR) [3 marks]

Draw block diagram of CCTV.

Answer:

CCTV System Block Diagram:

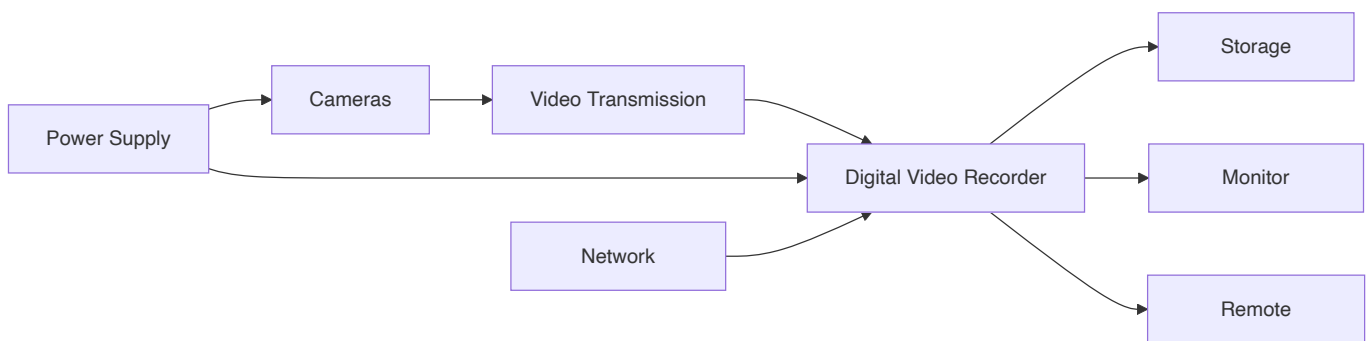

- **Cameras:** Capture video footage
- **Transmission:** Coaxial cable/IP network/Wireless
- **DVR/NVR:** Processes and records video
- **Storage:** Hard drives for footage retention
- **Monitor:** Displays live or recorded footage

Mnemonic: "CTDSM" - Camera, Transmission, DVR, Storage, Monitor system

Question 4(b OR) [4 marks]

List specifications of inkjet printer and Photocopier.

Answer:

Specifications:

Inkjet Printer Specifications	Photocopier Specifications
Print Resolution: 1200-4800 dpi	Copy Resolution: 600-1200 dpi
Print Speed: 8-20 ppm	Copy Speed: 20-60 cpm
Ink Type: Dye/Pigment	Toner Type: Dry/Liquid
Paper Capacity: 100-250 sheets	Paper Capacity: 250-2000 sheets
Connectivity: USB, Wi-Fi	Functions: Copy, Scan, Print, Fax
Duty Cycle: 1,000-5,000 pages/month	Duty Cycle: 10,000-100,000 pages/month

Mnemonic: "RSIPCD" - Resolution, Speed, Ink/toner, Paper capacity, Connectivity, Duty cycle

Question 4(c OR) [7 marks]

Explain working of LCD projector with block diagram and list its specifications.

Answer:

LCD Projector Working:

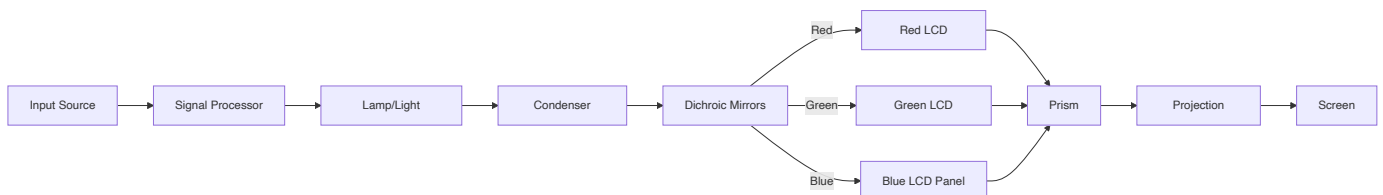

Working Process:

1. **Light Generation:** High-intensity lamp produces white light
2. **Color Separation:** Dichroic mirrors split light into RGB
3. **Modulation:** LCD panels control light intensity for each color
4. **Recombination:** Prism reassembles RGB images
5. **Projection:** Lens system projects image onto screen

Specifications:

- **Resolution:** XGA (1024×768), WXGA (1280×800), FHD (1920×1080)
- **Brightness:** 2000-5000 ANSI lumens

- **Contrast Ratio:** 2000:1 to 20000:1
- **Lamp Life:** 3000-6000 hours
- **Throw Ratio:** 0.5:1 to 2.0:1
- **Connectivity:** HDMI, VGA, USB, Wi-Fi

Mnemonic: "LSPMPS" - Lamp, Split, Panels, Modulate, Prism, Screen

Question 5(a) [3 marks]

Draw block diagram of PA system.

Answer:

Public Address (PA) System Block Diagram:

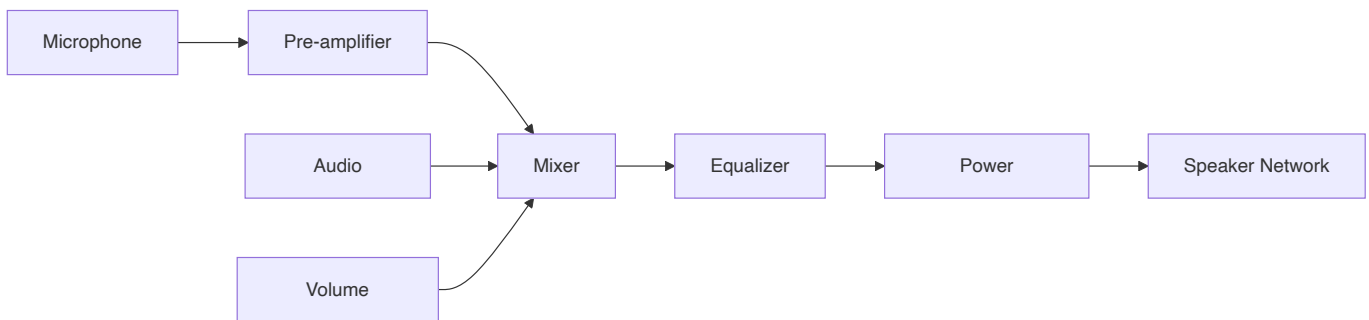

- **Microphone:** Converts sound to electrical signals
- **Pre-amplifier:** Boosts microphone signal
- **Mixer:** Combines multiple audio sources
- **Equalizer:** Adjusts frequency response
- **Power Amplifier:** Increases signal power
- **Speakers:** Convert electrical signals back to sound

Mnemonic: "MMEPS" - Microphone, Mixer, Equalizer, Power amp, Speakers

Question 5(b) [4 marks]

Explain tweeter and woofer.

Answer:

Speaker Components:

Feature	Tweeter	Woofers
Frequency Range	High (2kHz-20kHz)	Low (20Hz-2kHz)
Size	Small (0.5"-1.5")	Large (4"-15")
Diaphragm	Light, rigid (dome/cone)	Heavy, flexible cone
Voice Coil	Small diameter	Large diameter
Cabinet Design	Horn/sealed	Ported/sealed/bass reflex

Working Principle:

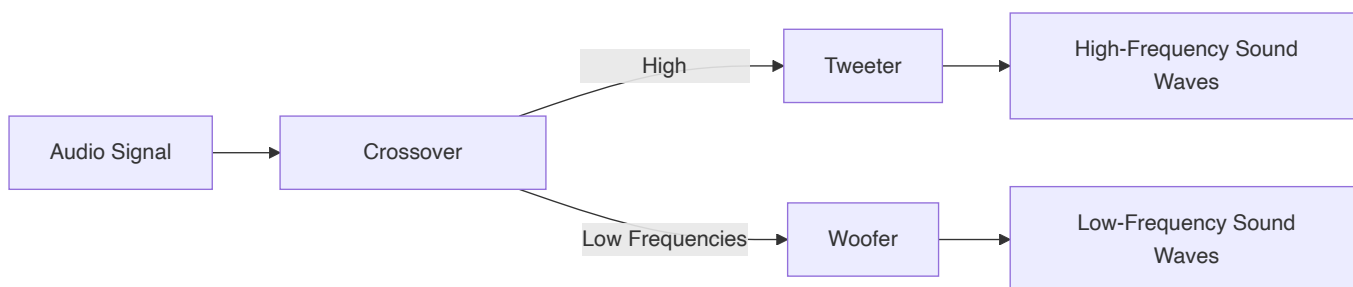

- **Tweeter:** Reproduces high frequencies with clarity and detail
- **Woofers:** Reproduces low frequencies with power and depth

Mnemonic: "THSL" - Tweeters handle Highs, Small and Light; Woofers handle Lows

Question 5(c) [7 marks]

Define microphone. List types of microphone and explain working of any one type of microphone.

Answer:

Microphone Definition:

A microphone is an electroacoustic transducer that converts sound waves into electrical signals.

Types of Microphones:

Type	Working Principle	Applications
Dynamic	Electromagnetic induction	Live performance, broadcasting
Condenser	Electrostatic principles	Studio recording, smartphones
Ribbon	Electromagnetic induction	Studio vocals, instruments
Carbon	Resistance variation	Old telephones
Piezoelectric	Piezoelectric effect	Contact mics, instruments
MEMS	Micro-electromechanical	Laptops, tiny devices

Dynamic Microphone Working:



- **Sound Capture:** Diaphragm vibrates with sound waves
- **Transduction:** Coil attached to diaphragm moves within magnetic field
- **Signal Generation:** Movement induces voltage proportional to sound intensity
- **Output:** Low impedance, strong signal requiring minimal amplification
- **Advantages:** Durable, handles high SPL, no external power needed

Mnemonic: "DDCMIO" - Diaphragm Displaces Coil in Magnetic field Inducing Output

Question 5(a OR) [3 marks]

Define: (1) Pitch (2) Loudspeaker (3) Reverberation.

Answer:

Definitions:

Term	Definition
Pitch	The perceived frequency of a sound that determines how "high" or "low" it sounds
Loudspeaker	An electroacoustic transducer that converts electrical signals into sound waves
Reverberation	The persistence of sound after the original sound has stopped due to multiple reflections

Diagram:

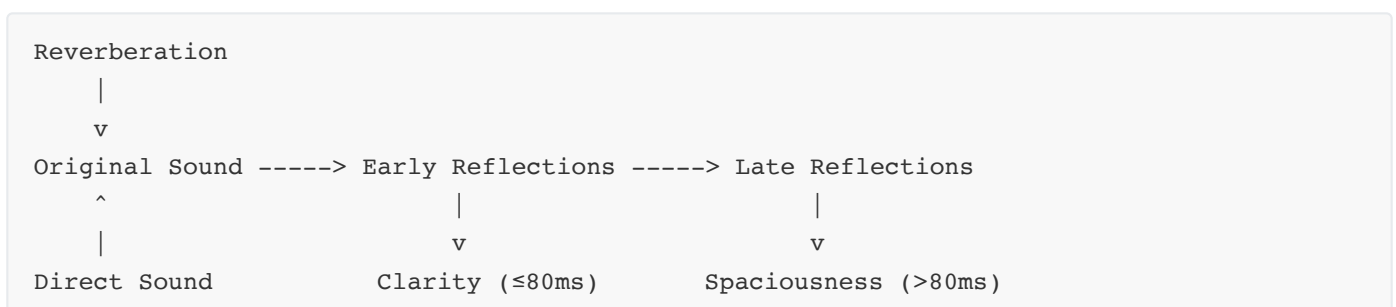

Mnemonic: "PLR Sound" - Pitch defines tone, Loudspeaker produces it, Reverberation extends it

Question 5(b OR) [4 marks]

Draw block diagram of Home theatre sound system and explain in brief.

Answer:

Home Theatre Sound System:

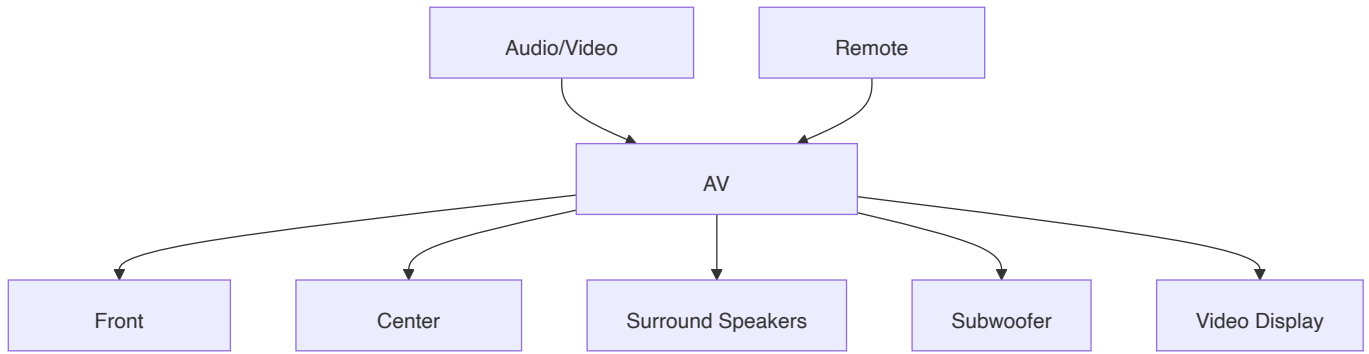

- **AV Receiver:** Central hub that processes audio/video signals
- **Front Speakers:** Left and right channels for stereo sound
- **Center Speaker:** Delivers dialog and central sounds
- **Surround Speakers:** Create immersive environment with ambient sounds
- **Subwoofer:** Reproduces low-frequency effects (LFE) below 120Hz
- **Configuration:** Common setups include 2.1, 5.1, 7.1, or 9.1 channel systems

Mnemonic: "AFSCS" - Amplifier drives Front, Surround, Center Speakers and Subwoofer

Question 5(c OR) [7 marks]

Explain Electrostatic loudspeaker and permanent magnet loudspeaker.

Answer:

Comparison of Loudspeaker Types:

Feature	Electrostatic Speaker	Permanent Magnet Speaker
Working Principle	Electrostatic forces between plates	Electromagnetic induction
Construction	Thin diaphragm between stator plates	Cone attached to voice coil in magnetic field
Power Requirements	Needs high voltage polarizing supply	No external power beyond signal
Frequency Response	Excellent mid/high frequency	Good across full range with proper design
Efficiency	Low (1-3%)	Moderate (2-5%)
Distortion	Very low	Moderate

Electrostatic Speaker Working:

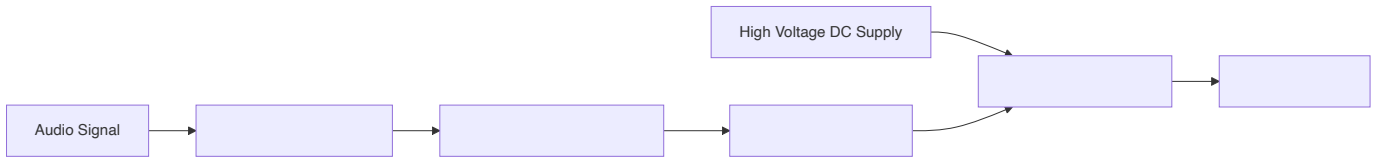

- **Diaphragm:** Thin, lightweight membrane with conductive coating
- **Operation:** Audio signal varies charge on stator plates, creating varying force on diaphragm

Permanent Magnet Speaker Working:

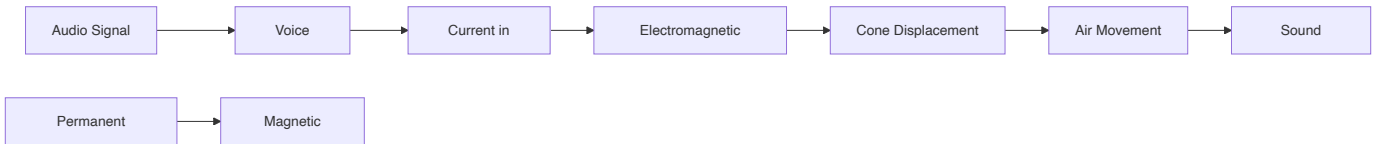

- **Voice Coil:** Winding of wire attached to speaker cone
- **Operation:** Current through coil creates magnetic field that interacts with permanent magnet
- **Advantages:** Robust design, good power handling, no high voltage required
- **Applications:** Most common speaker design for general audio reproduction

Mnemonic: "ESPM" - Electrostatic uses Static charges, Permanent Magnet uses Magnetic forces